

SECTION A-A

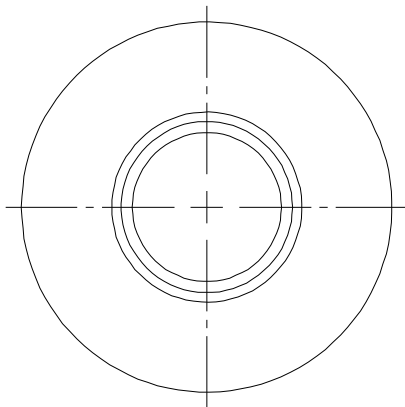
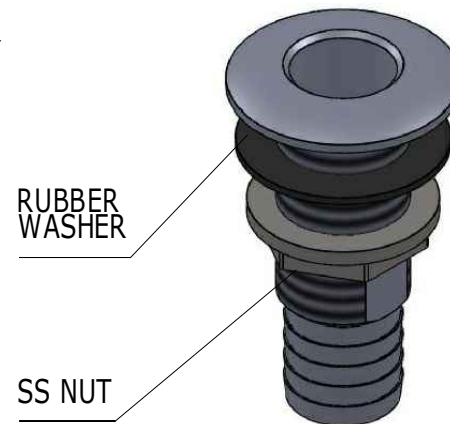
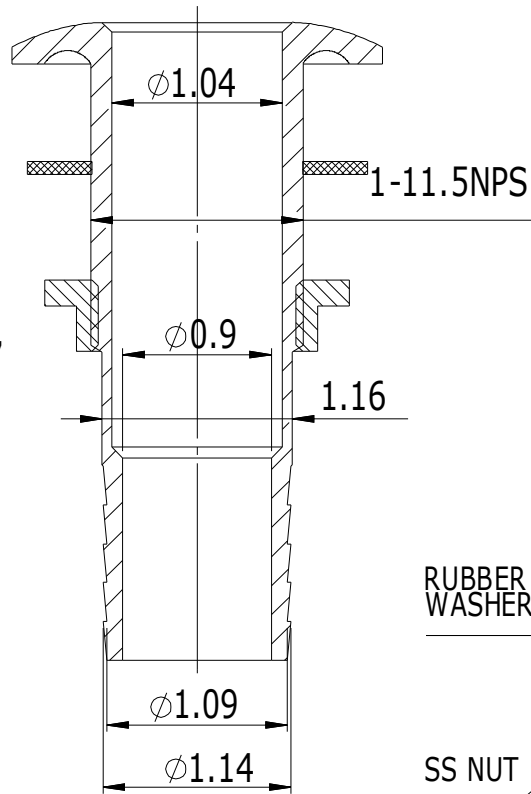

Whitecap			
Units	Inches	View	
P/N	6549		20180716